

Easy Peer-to-Peer Communication with Acromag i2o®

i2o input-to-output communication

Acromag's i2o technology provides the easiest way to link your inputs to your outputs without a PLC, PC or master CPU.

With i2o, many BusWorks 900EN I/O modules have the ability to operate like a long-distance transmitter. You can convert your sensor inputs at Point A to process control signals at Point B. Or, monitor a discrete device at one site by reproducing the discrete level with a relay output at another location.

Use your existing Ethernet lines to save time and wiring expenses

You can connect the input modules to the output modules using your existing copper/fiber infrastructure or with a single new cable. Multiple I/O modules can be multiplexed through a switch or wireless radios.

No complicated controllers. No software. No programming.

Acromag's Ethernet I/O modules have a built-in web page making it simple to configure using your standard web browser. Just click a few menu settings, enter the IP addresses, and you are done. Fast and easy.



BusWorks XT Series I/O Modules

Up to 12 channels per module and reliable, failsafe communication

Monitor up to a dozen devices with a single pair of I/O modules. Discrete I/O modules have twelve channels that you can set up as inputs or as outputs in four-channel groups. This allows bi-directional communication between two modules. Analog input modules measure up to six current, voltage, thermocouple, or RTD sensor signals. This data is then transmitted to a six-channel analog output module providing DC current or voltage output signals.

Wire-saving applications

Our i2o technology lets an input module speak directly to an output module. It is ideal for non-critical projects that don't need a PLC or PC master. Reproduce remote signals based on timed or event updates.

- Remote monitoring of process variables (temperature, pressure, level, flow) and discrete devices
- Remote data display, recording, alarms, or control
- Signal splitters
- Analyzer system monitoring
- Power and water utility monitoring
- Tank level, pump, and valve control
- Remote monitoring of motor loads and contactor status
- Remote control switching stations
- Environmental control systems
- Process shutdown, alarming, and annunciator systems
- RFID systems

Peer-to-Peer Communication

Analog Inputs

4-20mA, 0-10V DC, thermocouple, RTD/resistance

Discrete Inputs

on/off, high/low, open/close, momentary push-buttons

Any Ethernet Media

Copper, fiber, wireless, or Internet

Analog Outputs

proportional 4-20mA or 0-10V DC

Discrete Outputs

on/off, high/low, open/close

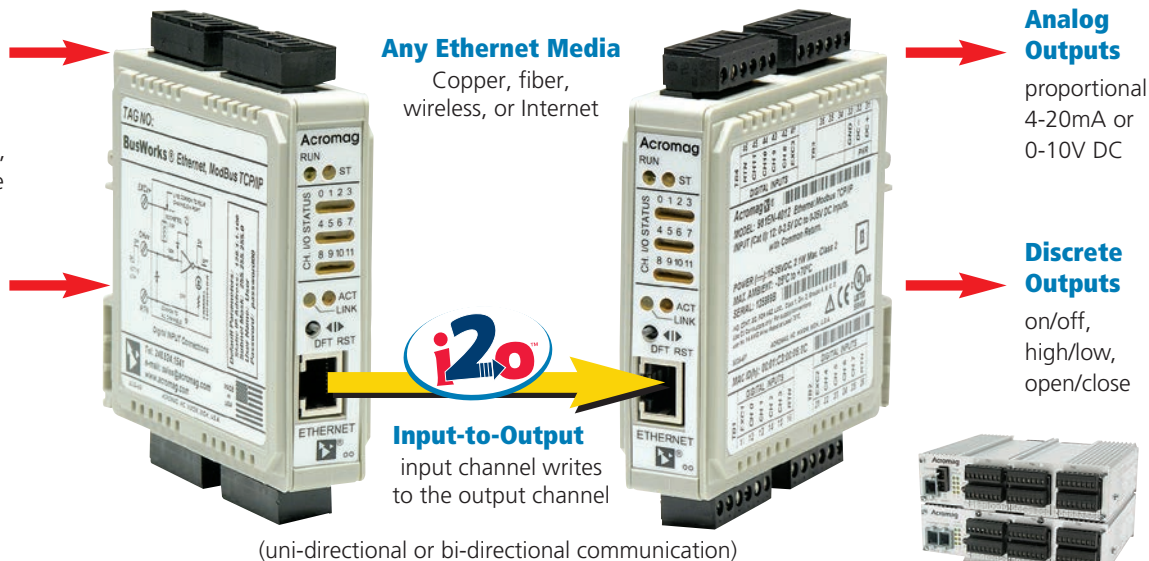

EtherStax I/O® also supports i2o

Ethernet I/O: BusWorks® XT Series



Acromag i2o® Technology for Peer-to-Peer Communication

XT Series Modules with i2o

Analog Input Modules

- XT1211
8 differential current inputs
- XT1221
8 differential voltage inputs
- XT1231
16 single-ended current inputs
- XT1241
16 single-ended voltage inputs

Discrete I/O Modules

- XT1111
16-channel sinking outputs
- XT1121
16-channel sourcing outputs

Combination I/O Modules

- XT1531
4 analog current outputs,
4 discrete I/O
- XT1541
8 analog voltage outputs,
4 discrete I/O

Installation #1: Copper Ethernet network



NOTE: Buy modules in pairs. For example:
AI with AO
DIO with DO or DIO
Combo with Combo

Installation #2: Fiber optic connection

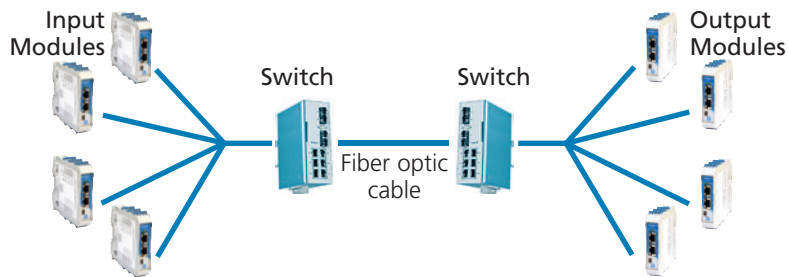

Installation #3: Wireless connection (telemetry systems)

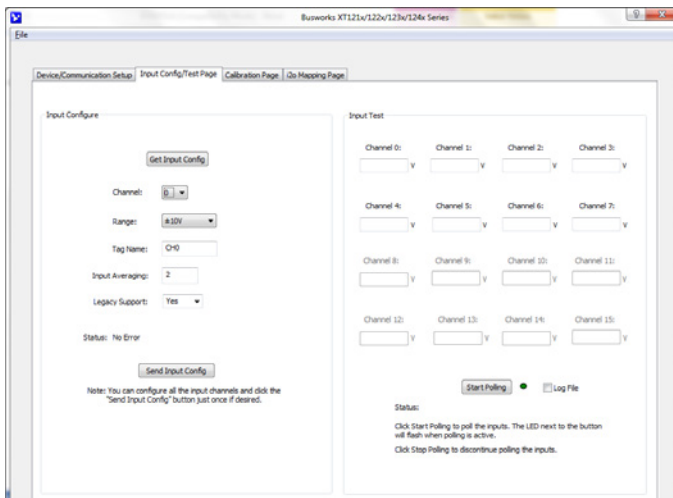
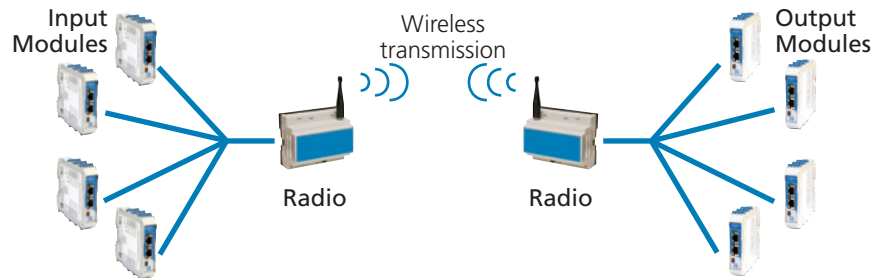

XT Module input configuration screen

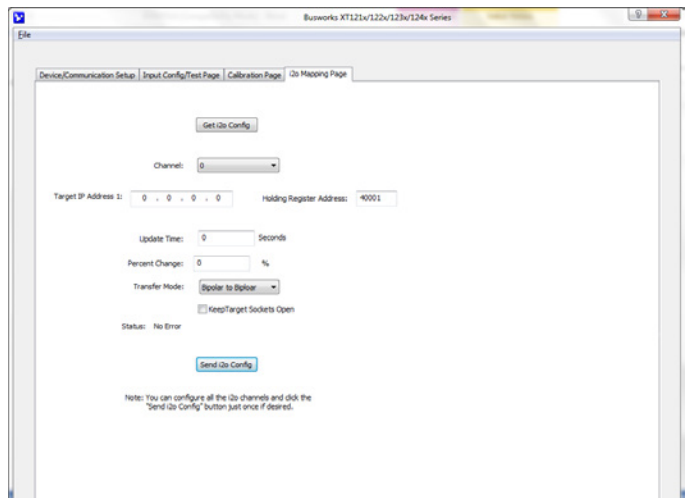

XT Module i2o mapping screen

Ethernet I/O: BusWorks® Series



Acromag i2o® Technology for Peer-to-Peer Communication

900EN Series Modules with i2o

Analog Input Modules

- 961EN / 962EN
6 differential current/voltage inputs
- 965EN
6 thermocouple/mV inputs
- 966EN
6 RTD/resistance inputs
- 967EN / 968EN
8 differential current/voltage inputs

Analog Output Modules

- 972EN
4 or 6 current outputs
- 973EN
4 or 6 voltage outputs

Discrete I/O Modules

- 982EN
12 solid-state relay outputs
- 983EN
12 solid-state input/outputs

Combination I/O Modules

- 951EN
4 analog current inputs,
2 analog current outputs, 6 discrete I/O
- 952EN
4 analog voltage inputs,
2 analog current outputs, 6 discrete I/O

Installation #1: Copper Ethernet network



NOTE: Buy modules in pairs. For example:
AI with AO
DIO with DO or DIO
Combo with Combo

Installation #2: Fiber optic connection

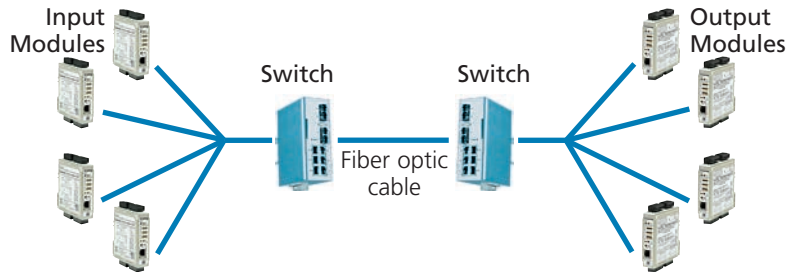

Installation #3: Wireless connection (telemetry systems)

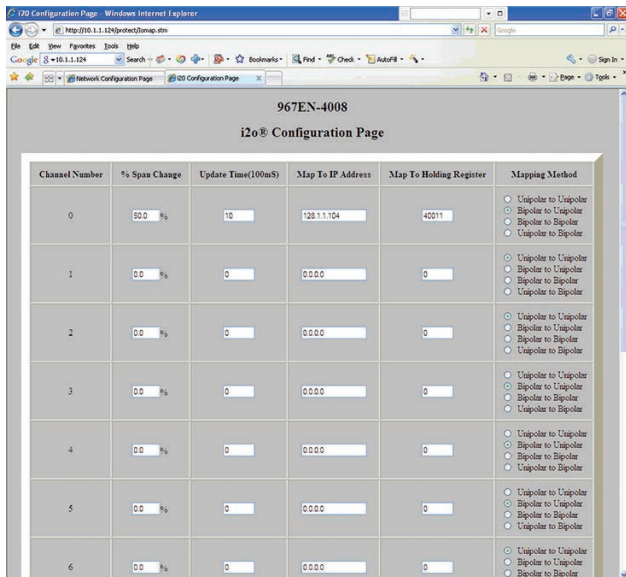
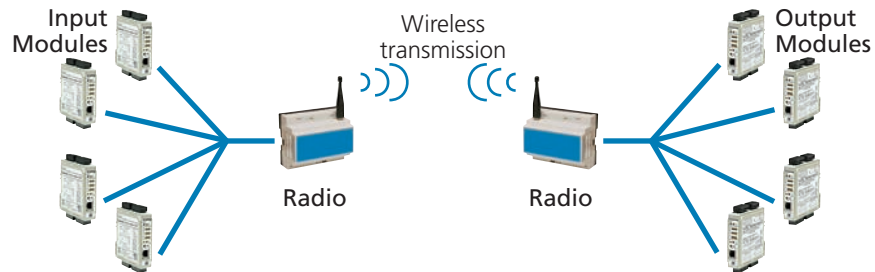

Analog input module configuration screen

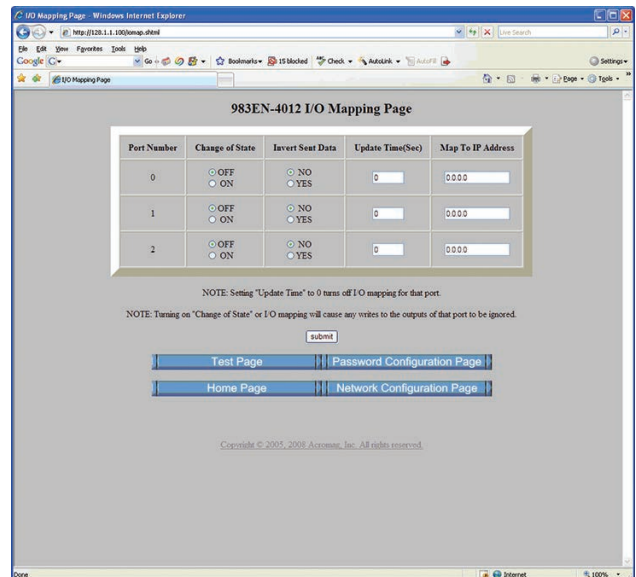

Discrete I/O module configuration screen

Ethernet I/O: EtherStax® Series



Acromag i2o® Technology for Peer-to-Peer Communication

ES2000 Series Units with i2o

◆ Analog Input Modules

ES2153

16 analog current inputs,
16 analog voltage or 8B inputs

◆ Analog Output Modules

ES2171

16 current outputs

ES2172

16 voltage outputs

◆ Analog I/O Modules

ES2151

16 analog current inputs,
16 analog voltage or 8B inputs,
16 analog current outputs

ES2152

16 analog current inputs,
16 analog voltage or 8B inputs,
16 analog voltage or 8B outputs

◆ Discrete I/O Modules

ES2113

96 solid-state input/outputs

ES2117

32 solid-state inputs

16 relay outputs

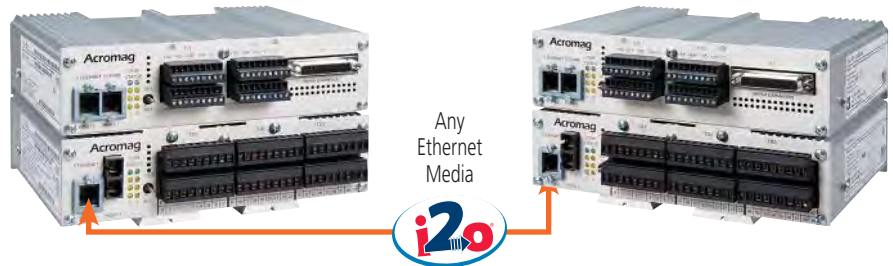

Installation #1: Peer-to-Peer Bi-directional Communication

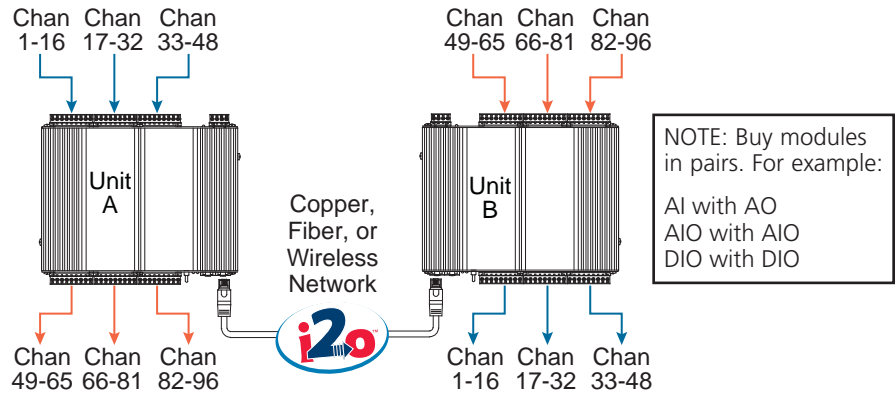

Installation #2: Peer-to-Peer Signal Splitter (dual outputs)

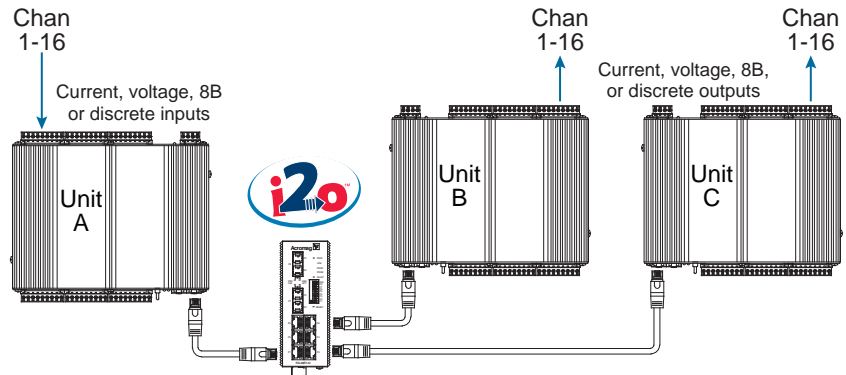

i2o® Configuration Page						
Port Number	% Span Change	Update Time(100ns)	Map To IP Address	Map To Holding Register	Mapping Method	Map To Internal Outputs
Port 1 Voltage	0.0	150	128.1.1.102	40251	<input type="radio"/> Unipolar to Unipolar <input type="radio"/> Bipolar to Unipolar <input type="radio"/> Bipolar to Bipolar <input type="radio"/> Unipolar to Bipolar	<input type="radio"/> NO <input checked="" type="radio"/> YES
Port 2 Voltage	0.0	0	0.0.0.0	0	<input type="radio"/> Unipolar to Unipolar <input type="radio"/> Bipolar to Unipolar <input type="radio"/> Bipolar to Bipolar <input checked="" type="radio"/> Unipolar to Bipolar	<input type="radio"/> NO <input checked="" type="radio"/> YES
Port 1 Current	0.0	0	0.0.0.0	0	<input type="radio"/> Unipolar to Unipolar <input type="radio"/> Bipolar to Unipolar <input type="radio"/> Bipolar to Bipolar <input type="radio"/> Unipolar to Bipolar	
Port 2 Current	0.0	0	0.0.0.0	0	<input type="radio"/> Unipolar to Unipolar <input type="radio"/> Bipolar to Unipolar <input type="radio"/> Bipolar to Bipolar <input type="radio"/> Unipolar to Bipolar	

Analog I/O module (ES2152) configuration screen

